

Oral History (Outreach services)

Oral History Adviser: Lynette Shum: 04 462 3977

Equipment hire: Celia Joe: 04 462 3935

ATLOutreach@dia.govt.nz

alexander.turnbull-library@dia.govt.nz

Using the Zoom H5¹

1 Setting up.

1.1 TURN OFF ALL MOBILE PHONES WITHIN THREE METRES' RADIUS – OR FLIGHT MODE

1.2 **Insert memory card:** Open cover on right-hand side, insert to slot. Close cover.

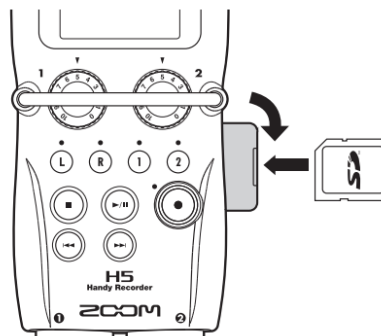

Note:

Make sure the power is **off** before inserting or removing a memory card, as failure to do so could result in data loss.

1.2 Rest recorder face up on foam insert from case to cushion.

1.3 Insert power cable jack at left-hand side, plug other end into point and switch on power at wall (not necessary when using battery power).

¹ A more technical manual is available on request, or see https://cvp.com/pdf/E_H5_0.pdf
Alexander Turnbull Library Lynette Shum CLIO # 562301 v-4 November 2016

1.4 Microphones

The big fat end is the jack that gets plugged into the recorder, the little end is the microphone. Each is labelled L (left) or R (right).

- The microphone travels ready to use, but may get knocked out of its clips. It should look like this, but if not...

Working with the last about 10 cms of wire closest to microphone, engage section of wire onto clip as shown. Use thumb (not nail!) to press firmly on wire over groove on clip until it is secure. Try not to tug on wire either side of holder. Leave loops of approximately 2-3cm.



- Insert jacks (the big fat end) to the bottom of recorder, left mic on the left (input 1), and right on the right (input 2), push in firmly avoiding any strain on the delicate cables.
- Uncoil lead of microphones, and either taking in a generous fold of clothing or using a lanyard or tie, clip to interviewee and self around breast-bone height. The positioning each mic is important: your voices should be travelling across the top of it. Make sure the mic remains on outside of clothes and points upwards, and is not likely to be knocked by jewellery or headphone cable. Bundle excess lead back up with twist tie/velcro to sit neatly by the recorder.

Input 2: Right (Input 1) - interviewee, left (input 2) - interviewer (i.e. you).

1.5 Headphones

- Plug firmly in to green 'Phones' jack on left of recorder. Coil any surplus length at recorder end and secure with a twist tie/velcro. Put the wire behind your shoulder and down your back, pulling the phones on from the back of your head instead of the front if it looks as if the phones cable might interfere with the mic.
- The phones are marked left and right on each of the sides.

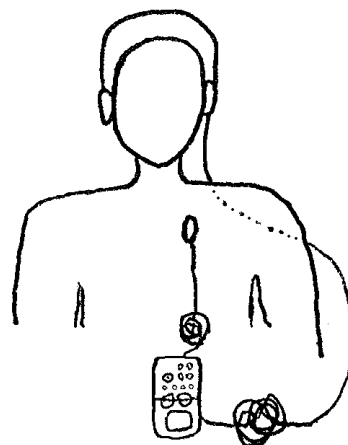

Slide  to .

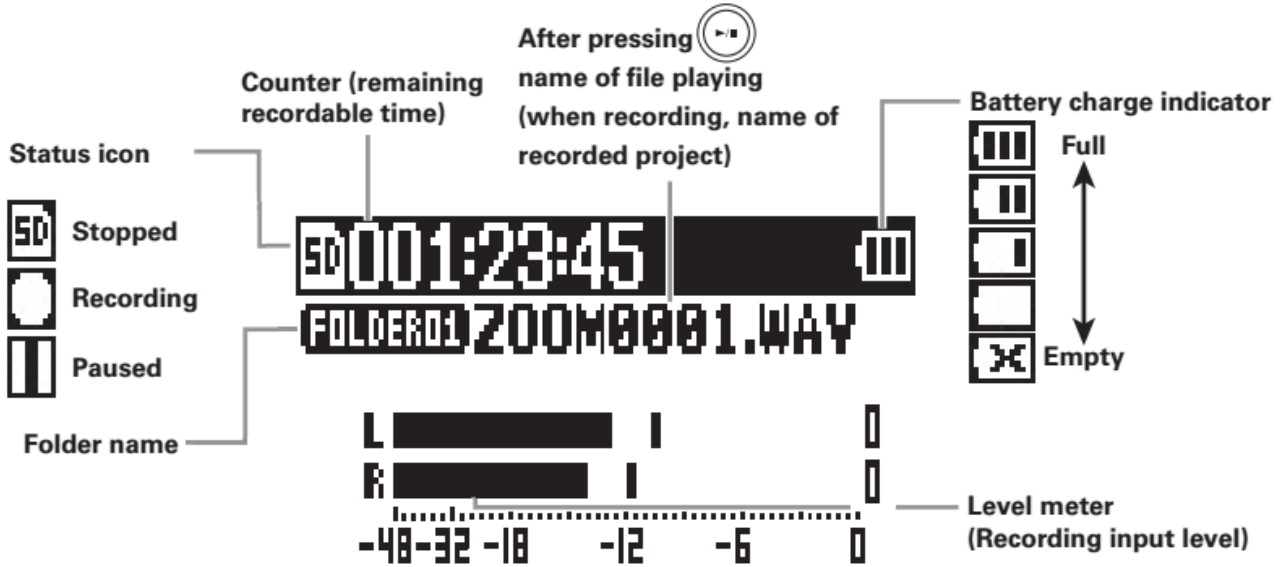

If this does not say WAV48-24, please contact Outreach services about adjusting the settings.

If these small red lights are not yet lit, press either the 1 or 2 input button.

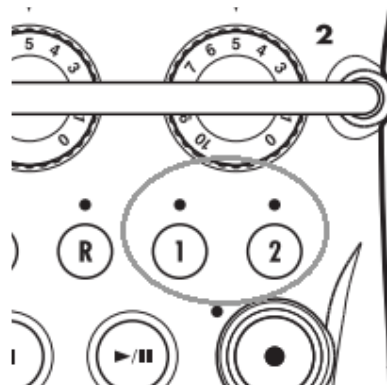

3 Setting the recording input levels

Adjust **Monitor** level using the volume button on left side of recorder so that the sound is at a level that is comfortable for you.

If it is too loud, too quiet, or you can't hear at all, this may need adjusting.

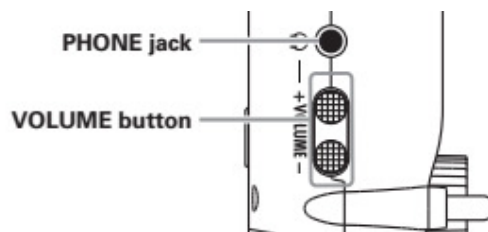

While you are each talking naturally about something that is not the topic of the interview, adjust each input volume dial in turn so that the **peak average** is around **-12** on the meter.

The bulk of the bar to the left will be going up and down all the time, but get the peak average indicator (small vertical line) to hang around -12 most of the time.

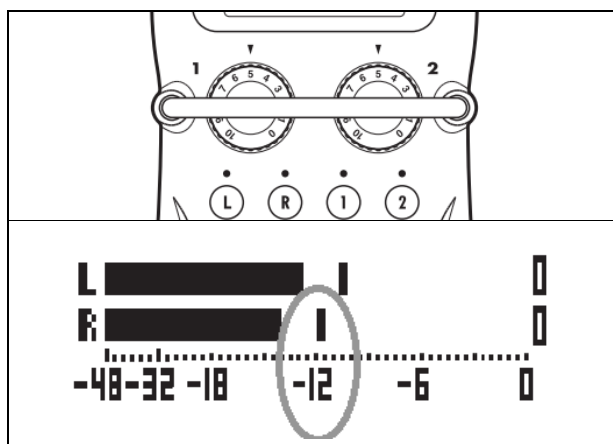

Now do a brief recorded test: press red Record button. You are now recording!

The file will be named with 'Zoom' and a sequence number starting with 00. Record a short test piece in which both speakers talk at a normal, natural level (breakfast, anyone?).

Press the Stop button on front of recorder when you have done this. Make sure both voices have been sampled.

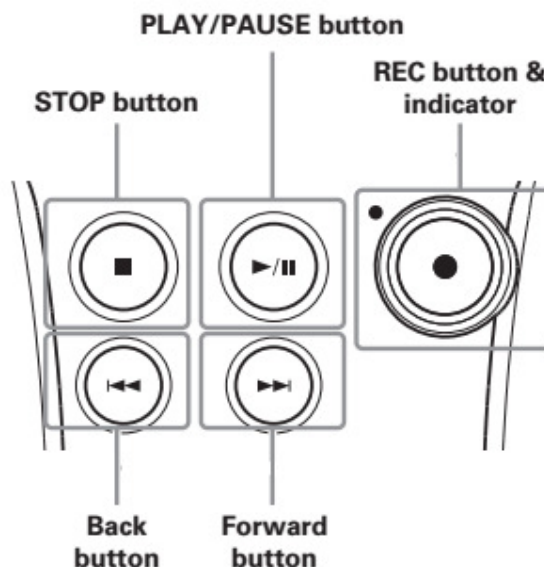

Play it back by pressing the Play button. Listen carefully.

Is it clean and clear? Are both voices of a similar volume? Check the levels again to confirm they are mostly hovering around -12.

You may need to turn one input volume dial down if that person is louder than the other, or move their mic further down their body and away from their mouth.

4 Start recording your interview

Only after you have listened to confirm a satisfactory test, begin the interview by pressing Record. If the test is not perfect, adjust recording levels, test and listen again, repeating as necessary.

Remember to start every interview file with a *file identification*. Keep track of which interview file number you are up to.

Keep your phones on. Wearing the headphones continuously means you will be able to pick up the sounds that may ruin a good interview that you wouldn't be able to pick up otherwise, such as interference or wire problems.

Occasionally throughout the interview, check the meter to make sure your recording levels are not too low or high. You may need to adjust the level during the interview. This is normal.

We recommend stopping after a maximum of one hour or one half-hour of continuous recording, so the files are not too large. You both deserve a break anyway.

5 After the interview

Turn recorder off



- Unplug microphones by pulling on jack, not the cable. Please coil each cable neatly, before gently returning to pouch, those wires are delicate!
- Unplug headphones and power, pack all away

Remove card and copy it as soon as is practicable

- Lift flap on right side of recorder
- Press on end of card to eject it
- **Use the card reader supplied**

One copy is no copy – copy at least 3 times, keeping one stored offsite



6 To reformat the card

This will remove **all** the files irreversibly, so make sure you have all wanted files saved **and** backed up elsewhere.

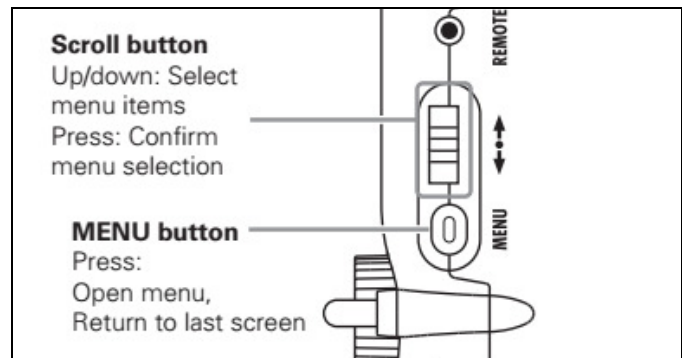

Insert card back into recorder, turn on.



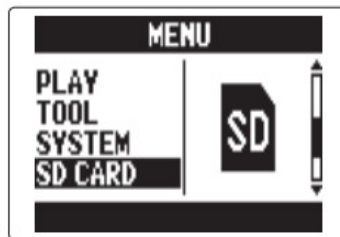

1. Press 

2. Use  to select "SD CARD", and press .

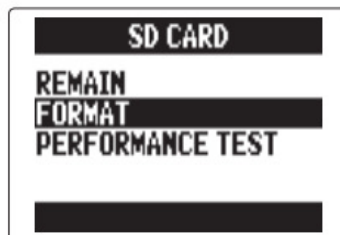

3. Use  to select "FORMAT", and press .



4. Use  to select "YES", and press .



5. Press  twice to get back to the home screen.



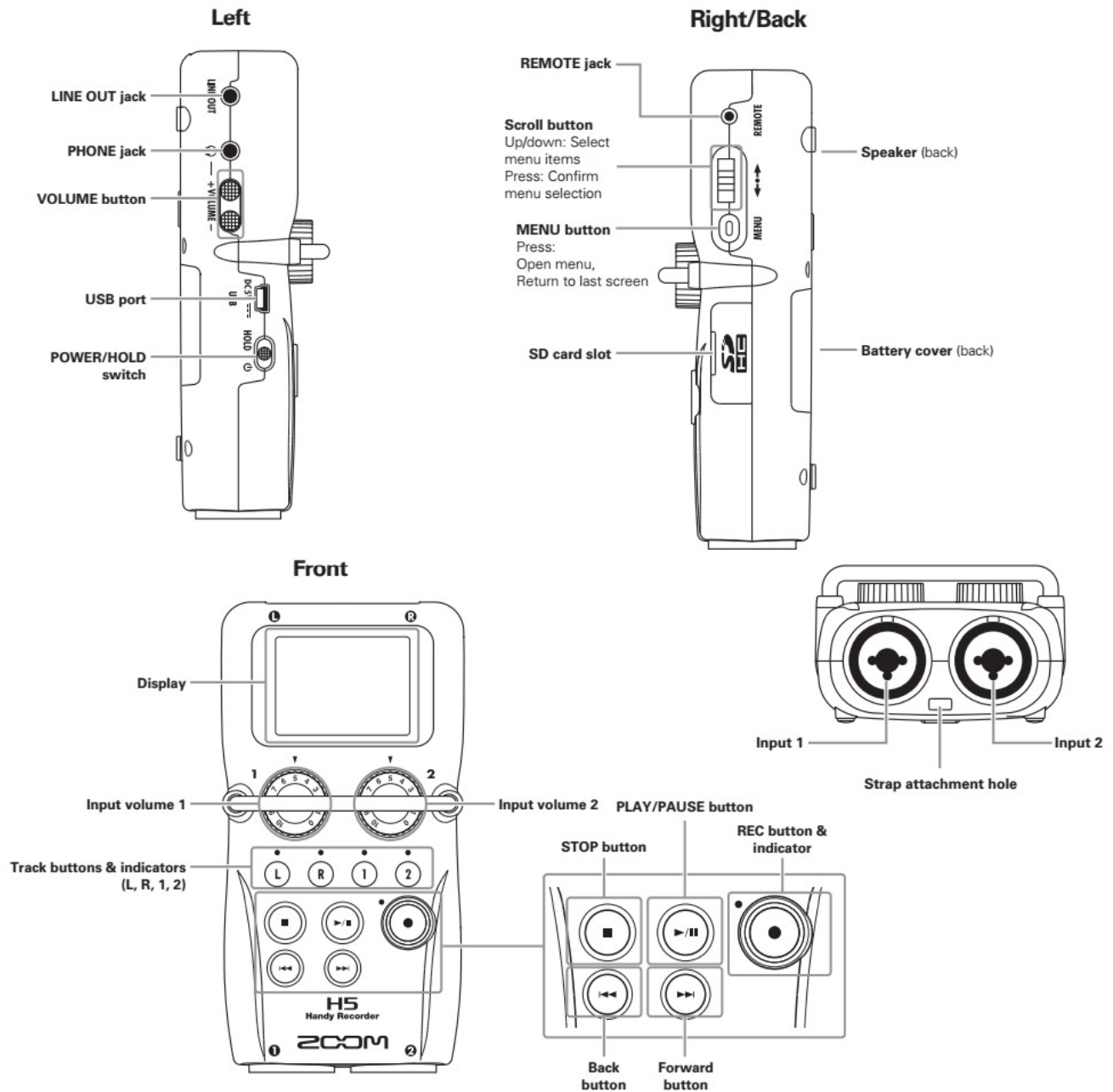

Names of parts



Optional accessories available

- Clip-on XY microphones
- Wind sock for microphones
- Tie pin for microphones
- Remote
- **Battery pack and charger**

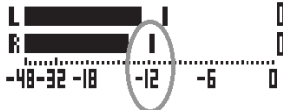
The recording process

1	Connect	Insert SD card Connect mics Position mics well <ul style="list-style-type: none"> • Left - l'er • Right - l'ee Connect headphones Connect power
↓		
2	Turn power on	Slide  to 
↓		
3	Prepare to record	Set recording levels <ul style="list-style-type: none"> • Peak average -12 dB 
↓		
4	Record test	
↓		
5	Check recording	Listen critically. Does it sound good? <ul style="list-style-type: none"> • Is it clean and clear? • Is the balance between interviewee and interviewer good? • Are the level readings good? Only proceed if perfect
↓		
6	Record interview	File ID!   File number

Slide  to 

Turn off recorder before removing memory card